

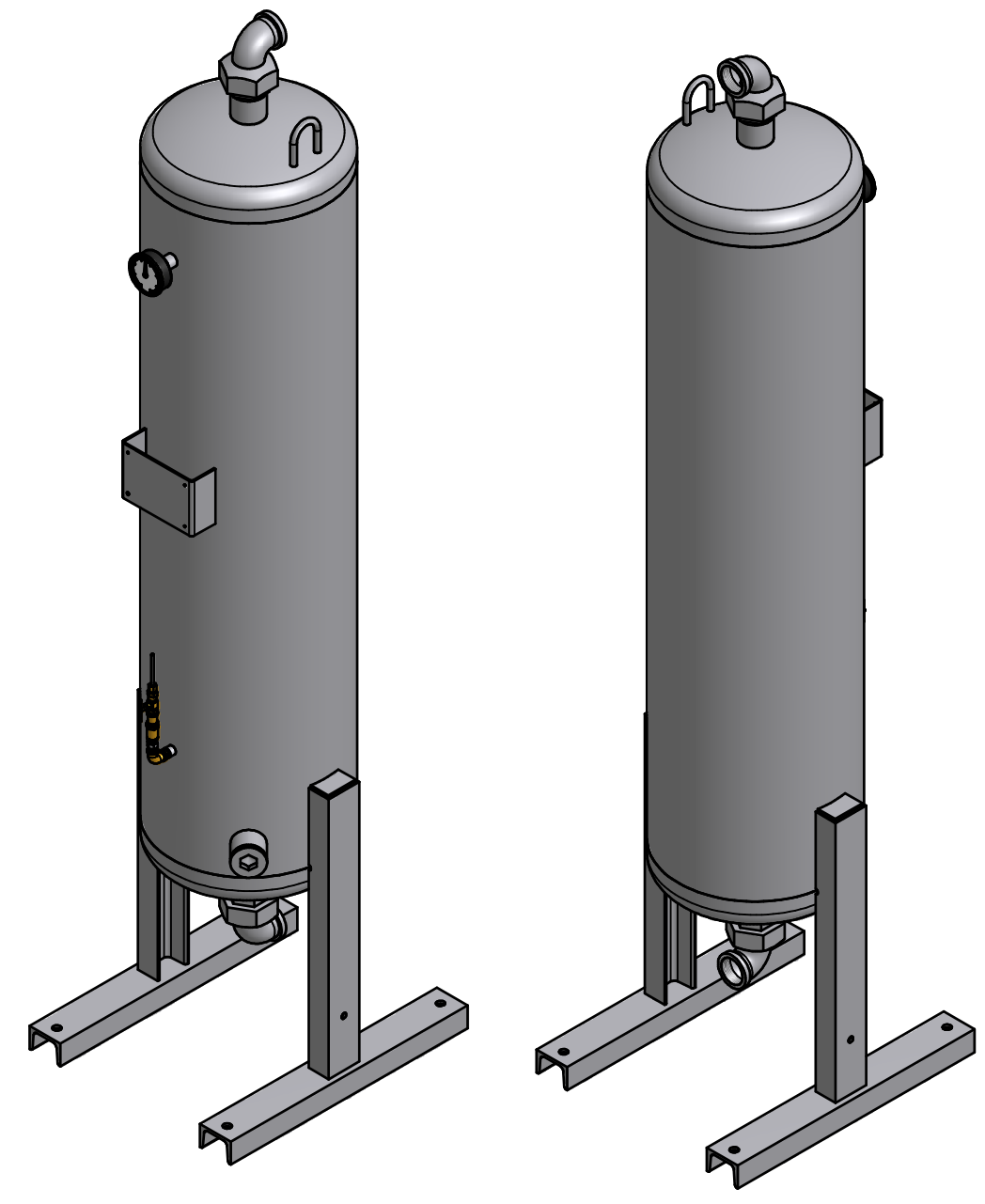

TEILELISTE						
OBJEKT	ANZAHL	BEZEICHNUNG	Zeichnungs-Nr.	NORM	MATERIAL	MASSE
1	1	Behälter, Typ DSS-60/16 A			Stahl/CS	95,024 kg
2	1	Staubsieb G 1 1/2	EIG-0070		1.4301	0,053 kg
3	2	Winkelverschraubung k.d., G 1 1/2, 1/A		DIN EN 10242	Messing/brass	1,300 kg
4	1	Ölprüfindikatoreinheit			Messing/brass	0,159 kg
5	1	Manometer NG 63, G, 0-25 bar, G 1/4 h			Standard	0,200 kg
6	1	Verschlußschraube G 1 1/2 mit Innensechskant		DIN 908	St. verz.	0,267 kg



Gesamtgewicht:
total weight: ~143 kg

				M 1:7.5	
		Datum		Name	
		Gezeichnet 07.06.2010		Lenke	
		Kontrolliert 07.06.2010		Tappe	
		Norm			
		 Filtrations-Separations-Technik		Aktivkohleadsorber DSS 60 activated carbon tower DSS 60	
		ZMP-S-000575		1	
				A2	
Status	Änderungen	Datum	Name		